

ICOM

INSTRUCTION MANUAL

VHF MARINE TRANSCEIVER

IC-M1EURO V

Icom Inc.

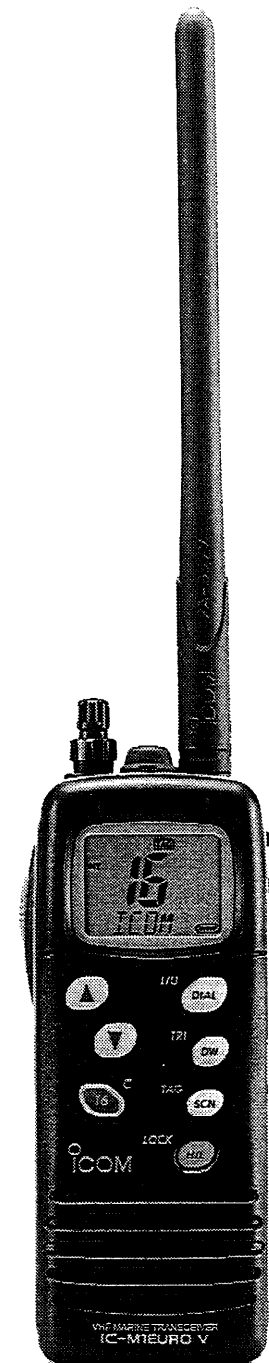

FOREWORD

Thank you for purchasing this Icom product. The IC-M1EURO V VHF MARINE TRANSCEIVER is designed and built with Icom's superior technology and craftsmanship. With proper care, this product should provide you with years of trouble-free operation.

IMPORTANT

READ ALL INSTRUCTIONS carefully and completely before using the transceiver.

SAVE THIS INSTRUCTION MANUAL— This instruction manual contains important operating instructions for the IC-M1EURO V.

EXPLICIT DEFINITIONS

WORD	DEFINITION
⚠ WARNING!	Personal injury, fire hazard or electric shock may occur.
CAUTION	Equipment damage may occur.
NOTE	Recommended for optimum use. No risk of personal injury, fire or electric shock.

CAUTION

⚠ WARNING! NEVER connect the transceiver to an AC outlet. This may pose a fire hazard or result in an electric shock.

⚠ WARNING! NEVER hold the transceiver so that the antenna is very close to, or touching exposed parts of the body, especially the face or eyes, while transmitting. The transceiver will perform best if the microphone is 5 to 10 cm away from the lips, and the transceiver is vertical.

NEVER connect the transceiver to a power source other than the BP-215. Such a connection will ruin the transceiver.

NEVER charge battery packs except in the methods described in this manual.

AVOID using or placing the transceiver in areas with temperatures below -15°C or above $+55^{\circ}\text{C}$.

AVOID the use of chemical agents such as benzine or alcohol when cleaning, as they may damage the transceiver surfaces.

After exposure to saltwater, clean the transceiver thoroughly with fresh water to avoid corrosion.

BE CAREFUL! The transceiver rear panel will become hot when operating continuously for long periods.

BE CAREFUL! The IC-M1EURO V employs waterproof construction, which corresponds to JIS waterproof specification, grade 7 (1 m/30 min.). However, once the transceiver has been dropped, waterproofing cannot be guaranteed due to the fact that the transceiver may be cracked, or the waterproof seal damaged, etc.

MAKE SURE the flexible antenna and battery pack are securely attached to the transceiver, and that the antenna and battery pack are dry before attachment. Exposing the inside of the transceiver to water will result in serious damage to the transceiver.

KEEP the transceiver at least 0.9 m away from the ship's navigation compass.

KEEP the transceiver out of the reach of children.

IN CASE OF EMERGENCY

If your vessel requires assistance, contact other vessels and the Coast Guard by sending a distress call on channel 16;

① USING CHANNEL 16

DISTRESS CALL PROCEDURE

1. "MAYDAY MAYDAY MAYDAY"
2. "THIS IS" (name of vessel)
3. Your call sign or other indication of the vessel
4. "LOCATED AT" (your position)
5. The nature of the distress and assistance required
6. Any other information which might facilitate the rescue

TABLE OF CONTENTS

FOREWORD	i	6 DUALWATCH/TRI-WATCH	14
IMPORTANT	i	■ Description	14
EXPLICIT DEFINITIONS	i	■ Operation	14
CAUTION	i	7 CHANNEL COMMENT PROGRAMMING	15
IN CASE OF EMERGENCY	ii	■ About the channel comment	15
TABLE OF CONTENTS	iii	■ Channel comment programming	15
1 OPERATING RULES	1	8 SET MODE	16–19
2 PANEL DESCRIPTION	2–5	■ SET mode programming	16
■ Front panel	2	■ SET mode items	16
■ Function display	4	9 BATTERY CHARGING	20–21
3 SUPPLIED ACCESSORIES AND ATTACHMENTS	6	■ Caution	20
4 BASIC OPERATION	7–11	■ Battery charging	20
■ Channel selection	7	10 SPEAKER-MICROPHONE	22
■ Lock function	8	■ Description	22
■ Automatic backlighting	8	■ Attachment	22
■ Receiving and transmitting	9	11 TROUBLESHOOTING	23
■ Optional voice scrambler operation	10	12 CHANNEL LIST	24
■ Call channel programming	11	13 QUICK REFERENCE	25
5 SCAN OPERATIONS	12–13	14 RECOMMENDATION	26
■ Scan types	12	15 SPECIFICATIONS AND OPTIONS	27
■ Setting tag channels	13	■ Specifications	27
■ Starting a scan	13	■ Options	27

◆ PRIORITIES

- ① Read all rules and regulations pertaining to priorities, and keep an up-to-date copy handy. Safety and distress calls take priority over all others.
- ② You must monitor channel 16 when you are not operating on another channel.
- ③ False or fraudulent distress signals are prohibited and punishable by law.

◆ PRIVACY

- ① Information overheard, but not intended for you, cannot lawfully be used in any way.
- ② Indecent or profane language is prohibited.

◆ RADIO LICENSES

(1) SHIP STATION LICENSE

You must have a current radio station license before using the transceiver. It is unlawful to operate a ship station which is not licensed.

Inquire through your dealer or the appropriate government agency for a Ship-Radiotelephone license application. This government-issued license states the call sign which is your craft's identification for radio purposes.

(2) OPERATOR'S LICENSE

A Restricted Radiotelephone Operator Permit is the license most often held by small vessel radio operators when a radio is not required for safety purposes.

The Restricted Radiotelephone Operator Permit must be posted or kept with the operator. Only a licensed radio operator may operate a transceiver.

However, non-licensed individuals may talk over a transceiver if a licensed operator starts, supervises, ends the call and makes the necessary log entries.

Keep a copy of the current government rules and regulations handy.

■ Panel description

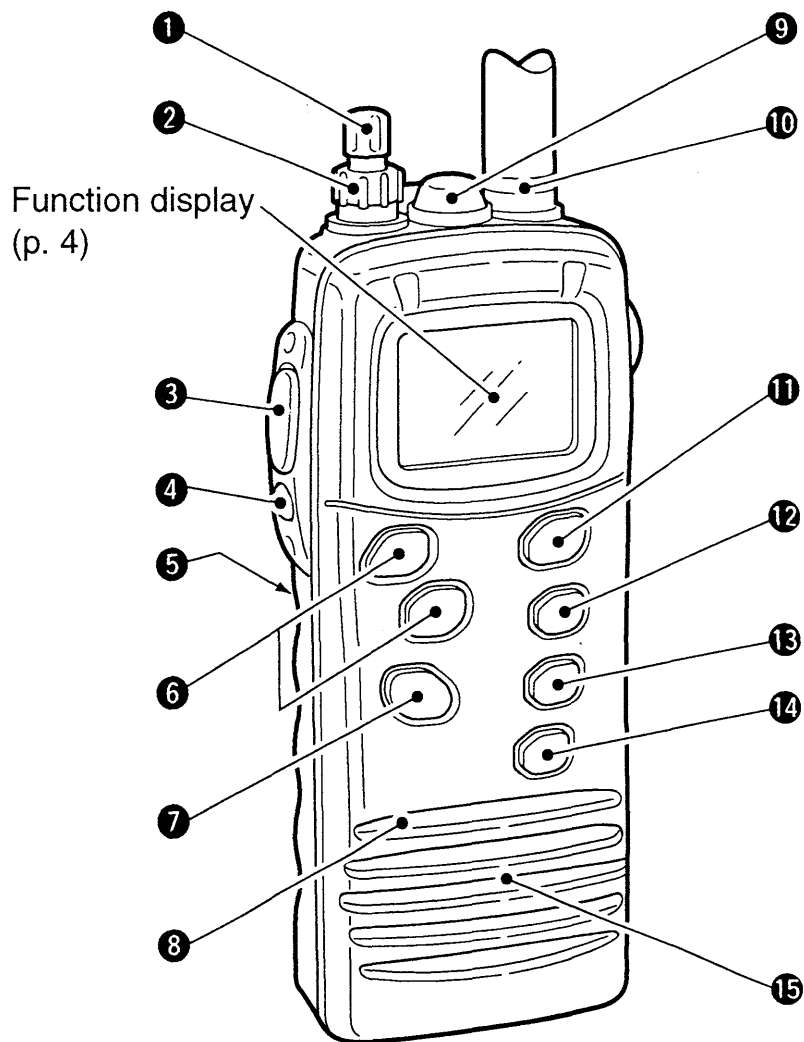

① VOLUME CONTROL [VOL]

Turns power ON and adjusts the audio level. (p. 9)

② SQUELCH CONTROL [SQL]

Sets the squelch threshold level. (p. 9)

③ PTT SWITCH [PTT]

Transmits during push; receives during release. (p. 9)

④ MONITOR SWITCH [MONI]

➔ Opens the squelch and monitors the operating channel while being pushed.

➔ While turning power ON, enters the SET mode and is used to select the SET mode contents when pushed. (p. 16)

⑤ BATTERY PACK RELEASE BUTTON

• *To remove the battery pack:* Slide the battery release button upwards, then lift up the battery pack.

• *To attach the battery pack:* Mate the notched ends of the transceiver and the battery pack, and click the battery pack into place firmly. Ensure that the battery is properly attached.

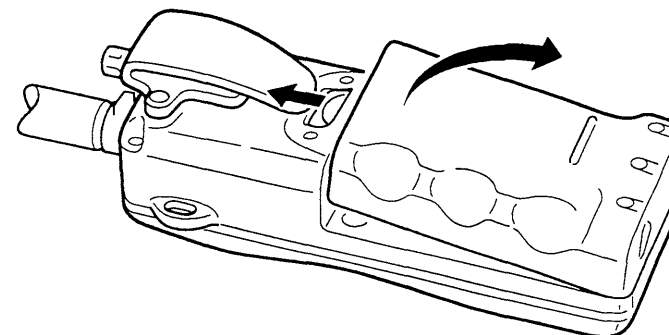

⑥ CHANNEL UP/DOWN SWITCHES [▲]/[▼]

- Push either switch to change the operating channel. (pgs. 7–9)
- Checks tag channels or changes scanning direction during scan. (p. 13)
- Push either switch to change the setting during set mode. (p. 16)

⑦ CHANNEL 16 SWITCH [16•C]

- Selects channel 16 when pushed. (p. 7)
- Selects the call channel when pushed for 1 sec. (p. 7)
- Enters call channel write mode when the call channel is selected, and this switch is pushed for 3 sec. (p. 11)

⑧ INTERNAL MICROPHONE (p. 9)

⑨ SPEAKER-MICROPHONE CONNECTOR [SP MIC]

Connects the optional speaker-microphone. (p. 22)

⑩ ANTENNA CONNECTOR

Connects the supplied antenna. (p. 6)

⑪ DIAL/CHANNEL GROUP SWITCH [DIAL•I/U]

- Selects and changes the regular channels. (p. 8)
- Selects one of 2 regular channels in sequence when pushed for 1 sec. (p. 8)
 - International and U.S.A. channels (UK and Italian versions only) are available for regular channels.

⑫ DUALWATCH/TRI-WATCH SWITCH [DW•TRI]

- Starts dualwatch when pushed momentarily. (p. 14)
- Starts tri-watch when pushed for 1 sec. (p. 14)
- Stops dualwatch/tri-watch when either is activated. (p. 14)
- Enters comment writing condition when pushed while pushing and holding [MONI]. (p. 15)

⑬ SCAN SWITCH [SCAN•TAG]

- Starts and stops normal or priority scan when tag channels are programmed. (p. 13)
- Sets the displayed channel as a tag (scanned) channel when pushed for 1 sec. (p. 13)
- While turning power ON, clears all tag channels in the selected regular channel group when pushed. (p. 13)
- Activates an optional voice scrambler function while pushing [MONI]. (p. 10)

⑭ TRANSMIT POWER/LOCK SWITCH [H/L•LOCK]

- Changes high and low power when pushed. (p. 9)
 - Some channels are set to low power only.
- While pushing [MONI], push this key to select extra low power. (p. 9: Not available for some versions)
- Changes the lock function ON and OFF when pushed for 1 sec. (p. 8)

⑮ INTERNAL SPEAKER

2 PANEL DESCRIPTION

■ Function display

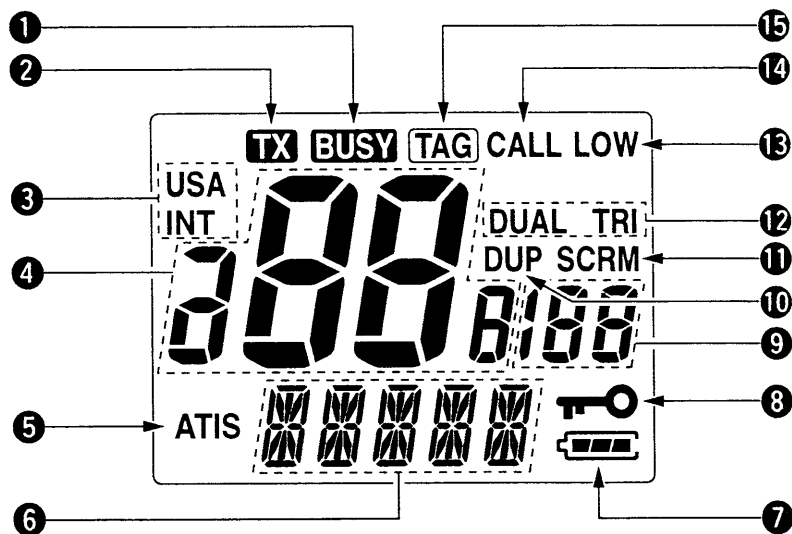

❶ BUSY INDICATOR (p. 9)

Appears while receiving a signal or while the squelch is open.

❷ TRANSMIT INDICATOR (p. 9)

Appears while transmitting.

❸ CHANNEL GROUP INDICATORS (p. 8)

Appears "INT" when International; "USA" when U.S.A. (UK and Italian versions only) channel group is selected.

❹ CHANNEL NUMBER READOUT

- Indicates the selected operating channel number. (pgs. 7, 8)
- In SET mode, indicates the selected condition. (pgs. 16–19)

❺ ATIS INDICATOR





Appears while ATIS function is activated. (German version only)

❻ COMMENT INDICATOR

- Indicates or scrolls operating channel comment, etc. (pgs. 7, 13, 15)
- In SET mode, indicates or scrolls the selected item. (pgs. 16–19)

7 BATTERY INDICATOR

Indicates remaining battery power.

Indication				
Battery level	Full	Middle	Charging required	No battery

8 LOCK INDICATOR (p. 8)

Appears while the lock function is activated.

9 SUB CHANNEL READOUT

- Indicates channel 16 during priority scan. (p. 13)
- Indicates channel 16 during dualwatch or tri-watch. (p. 14)

10 DUPLEX INDICATOR

Appears when a duplex channel is selected.

11 SCRAMBLER INDICATOR

Appears when the optional voice scrambler is activated.
(p. 10; Not available for some countries, due to local regulations)

12 DUALWATCH/TRI-WATCH INDICATORS (p. 14)

- “DUAL” blinks during dualwatch.
- “TRI” blinks during tri-watch.

13 LOW POWER INDICATOR (p. 9)

- Appears when low power is selected.
- Blinks when extra low power is selected.
(Not available for some versions)

14 CALL CHANNEL INDICATOR (p. 7)

Appears when a call channel is selected.

15 TAG CHANNEL INDICATOR (p. 13)

Appears when a tag channel is selected.

3

SUPPLIED ACCESSORIES AND ATTACHMENTS

◆ Supplied accessories

The following accessories are supplied: Qty.

- ① Flexible antenna (FA-S57V) 1
- ② Battery pack (BP-215) 1
- ③ Battery charger (AD-95) 1
- ④ AC adapter* (BC-122A/E/V*) 1
- ⑤ Handstrap 1
- ⑥ Belt clip 1
- ⑦ Screws for the belt clip (M3 × 4) 2
- ⑧ Screws for the AD-95 (M3.5 × 30)..... 2

*Depending on version

◆ Belt clip attachment

Attach the belt clip with the supplied screws. Conveniently attaches to your belt.

NEVER use the supplied screws without the belt clip, otherwise, the screw holes may be damaged and the transceiver might cease to be waterproof. Use the supplied screws only when attaching the belt clip.

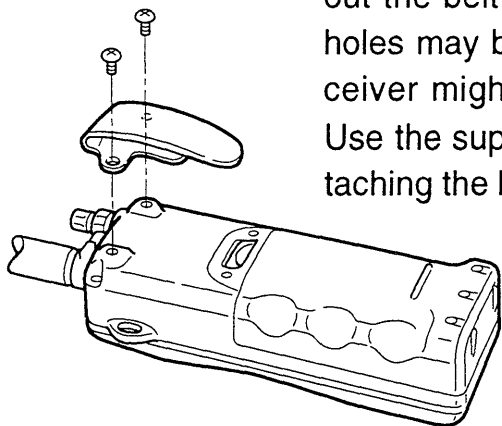

◆ Flexible antenna attachment

Insert the supplied antenna into the antenna connector and screw down the antenna as shown in the diagram at right.

CAUTION: Attach the supplied antenna securely for waterproofing.

CAUTION: Transmitting without an antenna may damage the transceiver.

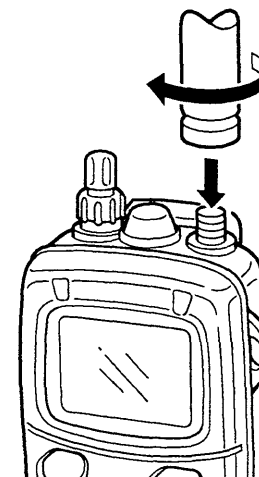

◆ Handstrap attachment

Slide the handstrap through the loop on the side of the transceiver as illustrated at right. Facilitates carrying.

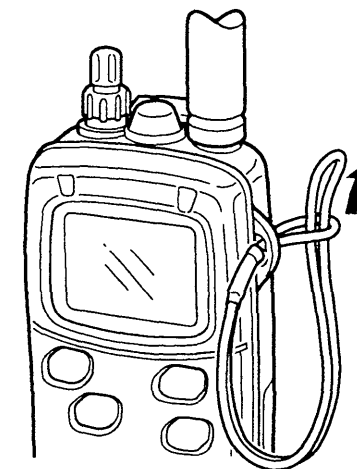

■ Channel selection

◇ Channel 16

Channel 16 is the distress channel. It is used for establishing initial contact with another station and for emergency communications. Channel 16 is automatically monitored during both dualwatch and tri-watch. While standing by, you must monitor channel 16.

- ➔ Push [16] to select channel 16.
- ➔ Push [DIAL] to return to the condition before selecting channel 16, or push [▲]/[▼] to select operating channel.

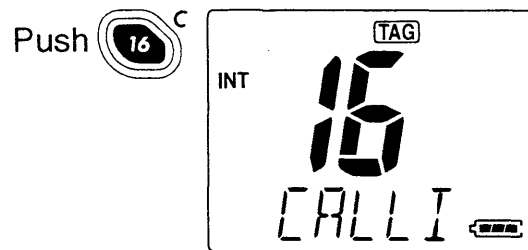

Scrolls the channel comment, *CALLING*.

◇ Call channel

Each regular channel group has separate leisure-use call channel. The call channel is monitored during tri-watch. The call channels can be programmed (p. 11) and are used to store your most often used channels in each channel group for quick recall.

- ➔ Push [16•C] for 1 sec. to select the call channel; of the selected channel group.
 - The “CALL” indicator and call channel number appear.
 - Each channel group may have an independent call channel after changing a call channel. (UK and Italian versions only)
- ➔ Push [DIAL] to return to the condition before selecting call channel, or push [▲]/[▼] to select operating channel.

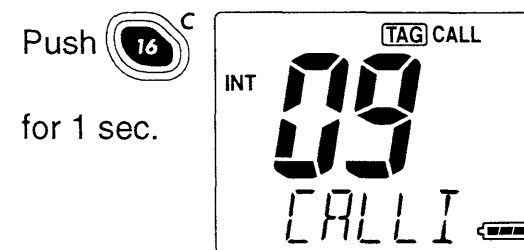

Scrolls the channel comment, *CALLING*.

4 BASIC OPERATION

◆ International and U.S.A. channels

There are 57 International channels for the IC-M1EURO V.

- ① Push [DIAL] to select a regular channel.
 - If a weather channel appears, push [DIAL] again.
- ② Push [▲]/[▼] to select a channel.
 - “DUP” appears for duplex channels.

◆ U.S.A. channels (UK and Italian versions only)

For the UK and Italian versions, there are 61 U.S.A. channels in addition to 57 International channels. These channel groups may be specified for the operating area.

- ① Push [DIAL] to select a regular channel.
 - If a weather channel appears, push [DIAL] again.
- ② To change the channel group, push [DIAL•I/U] for 1 sec. to change the channel group to International or U.S.A..
- ③ Push [▲]/[▼] to select a channel.
 - Channels are memorized separately for each channel group.

■ Lock function

This function electronically locks all keys and switches to prevent accidental frequency changes and function access.

- ➔ Push [H/L•LOCK] for 1 sec. to turn the lock function ON and OFF.
 - Only [PTT], [H/L] and [MONI] are functional.

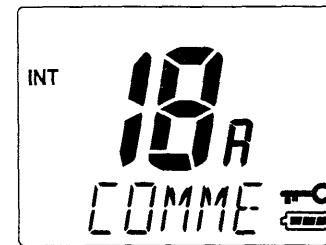

← Appears when the lock function is in use.

■ Automatic backlighting

This function is convenient for nighttime operation. The automatic backlighting can be activated in SET mode. (p. 18)

- ➔ Push any key except for [PTT] to turn the backlighting ON.
 - The backlighting is automatically turned OFF 5 sec. after operation.
 - Push [MONI] to turn the backlighting ON without changing the operating condition.

■ Receiving and transmitting

CAUTION: Transmitting without an antenna may damage the transceiver.

- ① Rotate [VOL] clockwise to turn power ON, then set to the 10 o'clock position.
 - Turn [SQL] clockwise to mute any audio noise if necessary.
- ② Push [▲]/[▼] to select the desired channel.
 - When receiving a signal, "BUSY" appears and audio is emitted from the speaker.
 - Further adjustment of [VOL] may be necessary at this point.
 - Use the optional voice scrambler function for privacy. (p. 10)
- ③ Push [H/L] to select the output power if necessary.
 - "LOW" appears when low power is selected.
 - Choose low power to conserve battery power, choose high power for longer distance communications.
 - Some channels are for low power only.
 - An extra low power, Low 2, is available for short distance communications. Push [H/L] while pushing [MONI] in such a case. (Not available for some versions)
- ④ Push and hold [PTT] to transmit, then speak into the mic.
 - "TX" appears.
 - Channel 70 cannot be used for transmission (GMDSS use only).

NOTE: Simplex channels, 3, 21, 23, 61, 64, 81, 82 and 83 **CANNOT** be lawfully used by the general public in USA waters.

- ⑤ Release [PTT] to receive.

IMPORTANT: To maximize the readability of your transmitted signal (voice), pause a few sec. after pushing [PTT], hold the microphone 10 to 15 cm from your mouth and speak at a normal voice level.

The transceiver has a power save function to conserve the battery power which can be turned OFF. The power save function activates automatically when no signal is received for 5 sec. See page 18 for details.

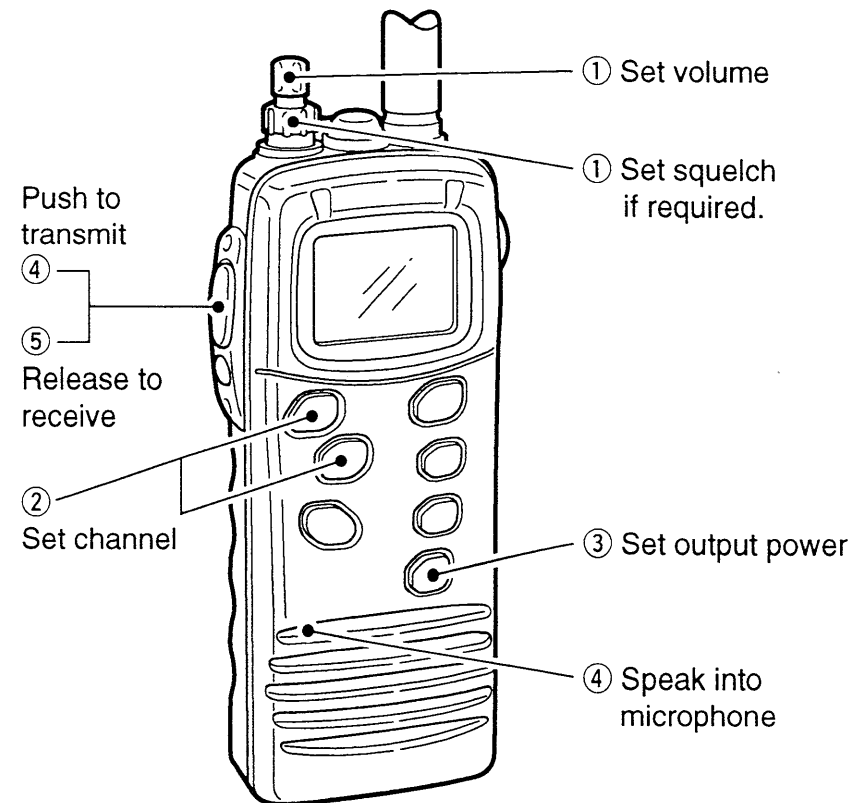

■ Optional voice scrambler operation

/// In some countries, this function is not available, since radio law varies according to country. To activate the function, an optional UT-98 or UT-112 is necessary. Ask your dealer for details.

◆ Activating the scrambler

The optional voice scrambler provides private communications. In order to receive or send scrambled transmissions, you must first activate the scrambler function. To activate the function, either an optional UT-98 or UT-112 is necessary. Ask your dealer for availability, and details.

- ① Select an operating channel except channel 16.
- ② Push [SCN] while pushing and holding [MONI].
 - “SCRM” appears.
- ③ To turn the scrambler function OFF, repeat step ②.
 - “SCRM” disappears.

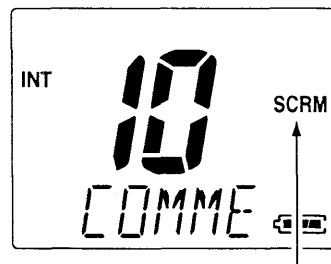

Appears when the voice scrambler function is in use.

◆ Programming scramble codes

There are 128 codes (00 to 127) available with UT-98 or 32 codes (01 to 32) available with UT-112 for programming. In order to understand one another, all transceivers in your group must have the same scramble code, as well as the same scrambler unit. See page 19 for scrambling code setting details.

/// **RECOMMENDATION:** Use the optional speaker-microphone during voice scrambling operation for much clearer audio readability.

■ Call channel programming

The call channel key can be programmed to your most often-used channels in each channel group for quick recall.

- ① Push [DIAL•I/U] for 1 sec. once or twice to select the desired channel group (USA, INT) to be programmed.

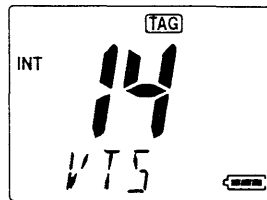

- ② Push [16•C] for 1 sec. to select the call channel of the selected channel group.
 - “CALL” and call channel number appear.

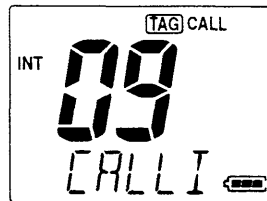

- ③ Push [16•C] again for 3 sec. (until long beep changes to 2 short beeps) to enter call channel programming condition.
 - Call channel number and channel group to be programmed flashes.

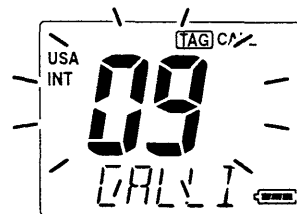

- ④ Push [▲]/[▼] to select the desired channel.

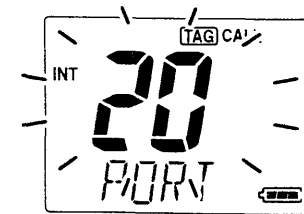

- ⑤ Push [16•C] to program the displayed channel as the call channel.
 - The call channel number and channel group stop flashing.

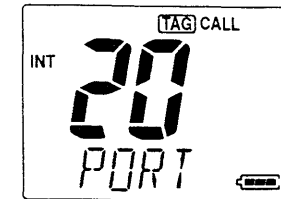

■ Scan types

Scanning is an efficient way to locate signals quickly over a wide frequency range. The transceiver has priority scan and normal scan.

In addition, weather alert and an automatic scan start function is available for standby convenience. (pgs. 17, 18)

Set the tag channels (scanned channel) before scanning. (Clear the tag channels which may inconveniently stop scanning, such as those for digital communication use.)

/// Choose priority or normal scan in SET mode. (p. 17)

PRIORITY SCAN

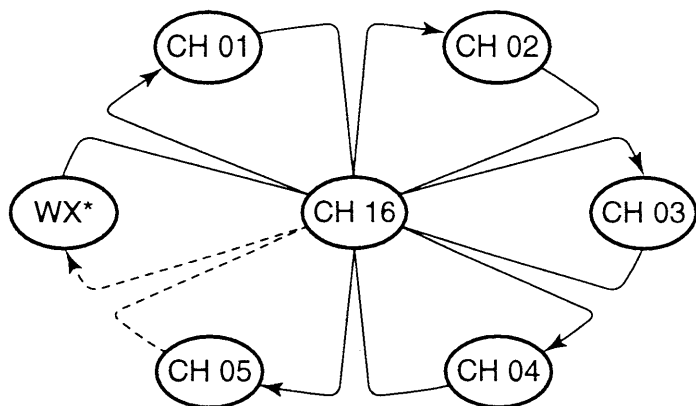

Priority scan searches through all tag channels in sequence while monitoring channel 16. When a signal is detected on channel 16, scan pauses until the signal disappears; when a signal is detected on a channel other than channel 16, scan becomes dualwatch until the signal disappears.

NORMAL SCAN

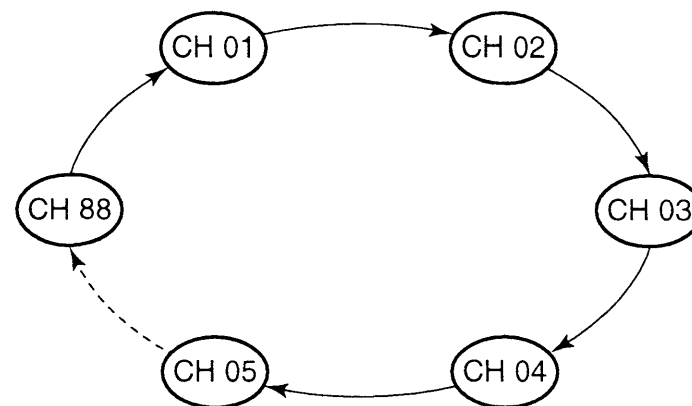

Normal scan, like priority scan, searches through all tag channels in sequence. However, unlike priority scan, channel 16 is not checked unless channel 16 is set as a tag channel.

■ Setting tag channels

For more efficient scanning, add desired channels as tag channels or clear preset tag channels if they are unwanted channels. Channels, set as non-tag channels will be skipped during scanning. Tag channels can be assigned to each channel group (USA, INT) independently.

- ① Select the desired channel group (USA, INT) by pushing [DIAL•I/U] for 1 sec., if desired.
- ② Select the desired channel to set as a tag channel.
- ③ Push [SCN•TAG] for 1 sec., to be set the displayed channel as a tag channel.
 - “TAG” appears in the function display.
- ④ To cancel the tag channel setting, push [SCN•TAG] for 1 sec.
 - “TAG” disappears.

•Clearing all tag channels in the selected channel group

➔ Turn power ON while pushing and holding [SCN•TAG] to clear all tag channels in the channel group.

■ Starting a scan

Set scan type, weather alert function, scan resume timer and auto scan function in advance, using SET mode. (pgs. 17, 18)

- ① Select the desired channel group (USA, INT) by pushing [DIAL•I/U] for 1 sec., if desired.
 - When the weather alert function is in use, select the desired weather channel with [DIAL] and the channel selector.
- ② Push [SCN] to start priority or normal scan.
 - The comment indicator flashes “SCAN”.
 - The sub channel readout indicates “16” during priority scan.
 - When a signal is received, scan pauses until the signal disappears, or resumes after pausing for 5 sec. according to the SET mode setting. (Channel 16 is still monitored during priority scan.)
 - Push [▲]/[▼] to check the scanning tag channels, to change the scanning direction or resume the scan manually.
- ③ To stop the scan, push [SCN].
 - “SCAN” disappears.
 - Pushing [PTT], [16•C], [DIAL] or [DW•TRI] also stops the scan.

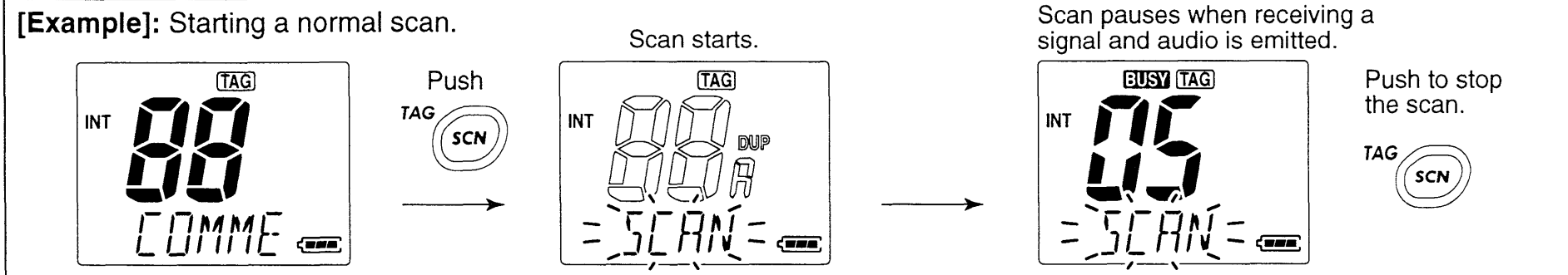

■ Description

Dualwatch monitors channel 16 while you are receiving another channel; tri-watch monitors channel 16 and the call channel while receiving another channel.

DUALWATCH/TRI-WATCH SIMULATION

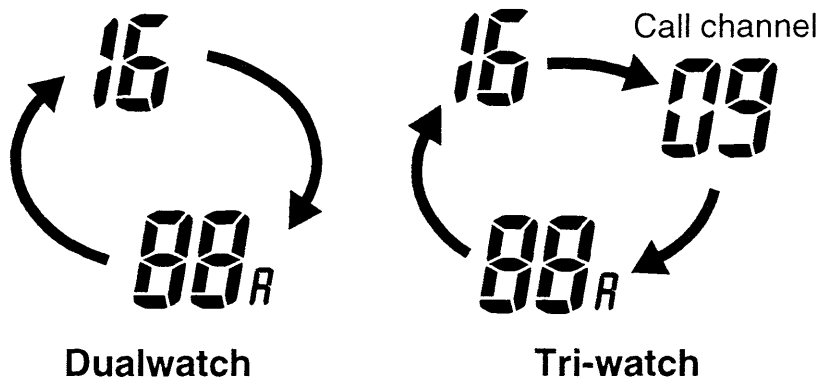

- If a signal is received on channel 16, dualwatch/tri-watch pauses on channel 16 until the signal disappears.
- If a signal is received on the call channel during tri-watch, tri-watch becomes dualwatch until the signal disappears.
- To transmit on the selected channel during dualwatch/tri-watch, push and hold [PTT].
- If no signal is received, the transceiver enters the power saving condition, after checking the operating channel every cycle.

■ Operation

- ① Select the desired operating channel.
- ② Push [DW•TRI] momentarily to start dualwatch; push [DW•TRI] for 1 sec. to start tri-watch.
 - "DUAL" flashes during dualwatch; "TRI" flashes during tri-watch.
 - Beep tone sounds when a signal is received on channel 16.
 - Tri-watch becomes dualwatch when receiving a signal on the call channel.
- ③ To cancel dualwatch/tri-watch, push [DW•TRI] again.

[Example]: Operating tri-watch on INT channel 07.

Push for 1 sec.

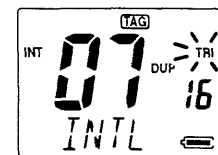

Tri-watch starts.

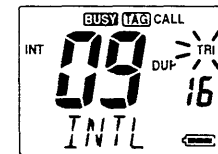

Signal is received on call channel.

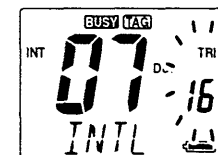

Signal received on channel 16 takes priority.

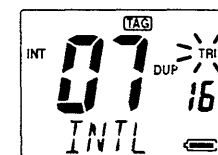

Tri-watch resumes after the signal disappears.

■ About the channel comment

The IC-M1EURO V has a capability to assign up to 10-character channel comments for each operating channel, including the weather channel. This provides easy recognition of channel usage, or station names, etc.

When shipped from the factory, the IC-M1EURO V is programmed with default comments for each VHF marine channel. These defaults can be overwritten if desired.

◇ Available characters

-- (=)	+ (+)	-- (-)	* (*)	/ (/)	, (,)	(space)	0 (0)	1 (1)	2 (2)
3 (3)	4 (4)	5 (5)	6 (6)	7 (7)	8 (8)	9 (9)	A (A)	B (B)	C (C)
D (D)	E (E)	F (F)	G (G)	H (H)	I (I)	J (J)	K (K)	L (L)	M (M)
N (N)	O (O)	P (P)	Q (Q)	R (R)	S (S)	T (T)	U (U)	V (V)	W (W)
X (X)	Y (Y)	Z (Z)	a (a)	b (b)	c (c)	d (d)	e (e)	f (f)	g (g)
h (h)	i (i)	j (j)	k (k)	l (l)	m (m)	n (n)	o (o)	p (p)	q (q)
r (r)	s (s)	t (t)	u (u)	v (v)	w (w)	x (x)	y (y)	z (z)	

■ Channel comment programming

- ① Push [▲]/[▼] to select a channel to program.

- Push [DIAL•I/U] for 1 sec. to select a channel group, if necessary.

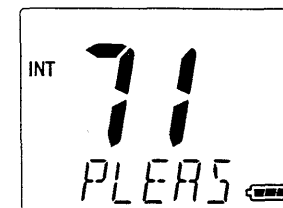

- ② While pushing [MONI], push [DW].

- The 1st character of the currently programmed comment flashes.

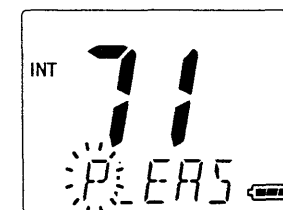

- ③ Push [▲]/[▼] to select a character.

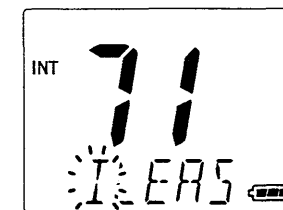

- ④ Push [SCN] to move to the right; then push [▲]/[▼] to select a character.

- Pushing [H/L], moves to left

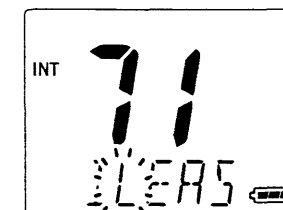

- ⑤ Continue until the desired characters have been selected, then push [DW] to return to normal operation.

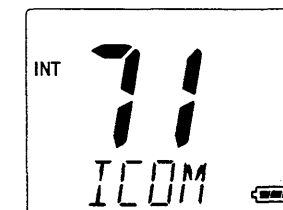

■ SET mode programming

SET mode is used to change the condition of 10 of the transceiver's functions: beep tone function, weather alert function, scan type (normal/priority), scan resume timer, auto scan function, automatic backlighting, power save function, self check function, voice scrambler type and scrambling code.

When no optional voice scrambler unit is installed, voice scrambler type and scrambling code cannot be set. (will not be displayed)

- ① Turn power OFF.
- ② While pushing [MONI], turn power ON and continue pushing [MONI] until a beep is emitted.
 - After beep emission, release [MONI].
 - Set mode item at comment indicator and condition at channel number readout are displayed.
- ④ Push [MONI] to select the desired item, if necessary.
- ⑤ Push [▲]/[▼] to select the desired condition of the item.
- ⑥ To exit SET mode, push [16].
 - Turning power OFF, then ON again also exits SET mode.

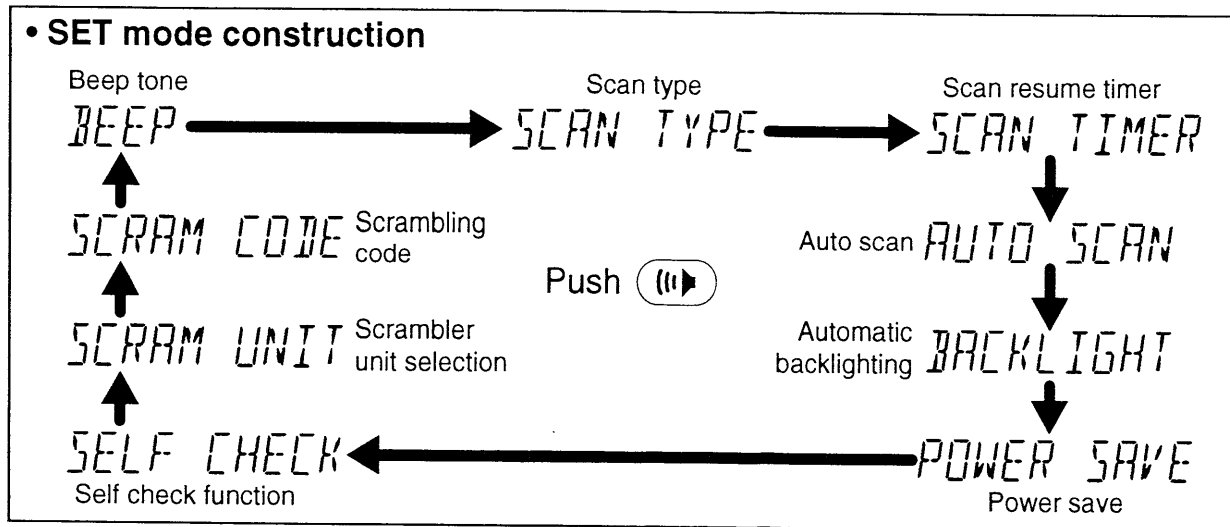

■ SET mode items

◆ Beep tone “BEEP”

You can select silent operation by turning the beep tones OFF, or you can have confirmation beeps sound at the push of a switch, by turning the beep tones ON. The beep tone volume is linked with [VOL].

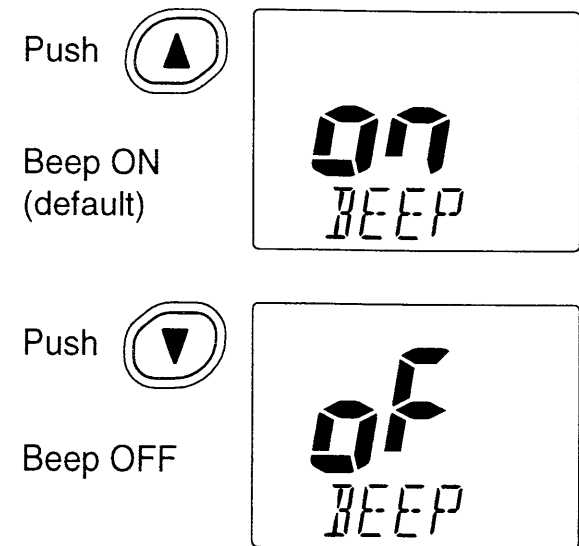

◆ Scan type selection
“SCAN TYPE”

The transceiver has 2 scan types: normal scan and priority scan. Normal scan searches all tag channels in the selected channel group. Priority scan searches all tag channels in sequence while monitoring channel 16.

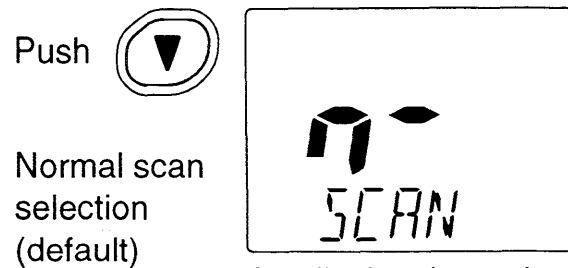
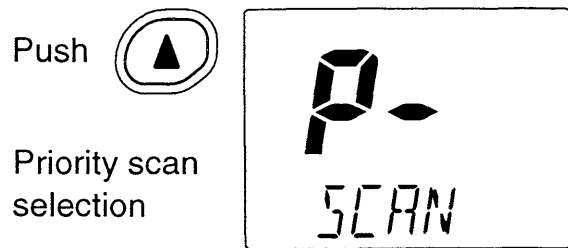

Scrolls the channel comment, “SCAN TYPE”.

◆ Scan resume timer
“SCAN TIMER”

The scan resume timer can be selected as a pause (OFF) or timer scan (ON). When OFF is selected, the scan pauses until the signal disappears. When ON is selected, the scan pauses 5 sec. and resumes, even if a signal is being received on channels, other than channel 16.

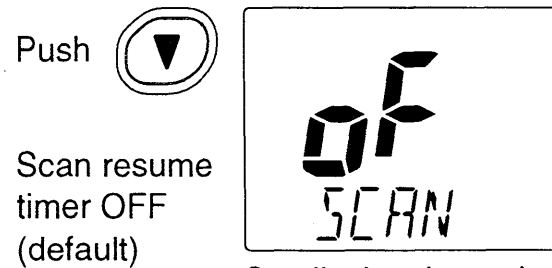
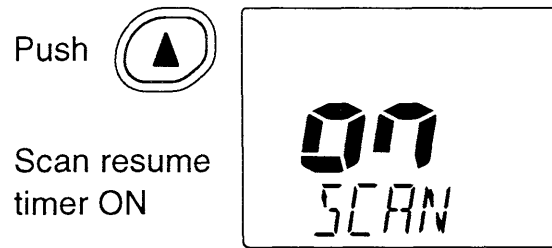

Scrolls the channel comment, “SCAN TIMER”.

◆ Auto scan function
“AUTO SCAN”

While in standby, this function automatically starts the desired scan (normal or priority scan) 30 sec. after operation.

- The comment indicator indicates “SCAN” while scanning.

 The transceiver has a power save function, but it does not activate when the auto scan function is in use.

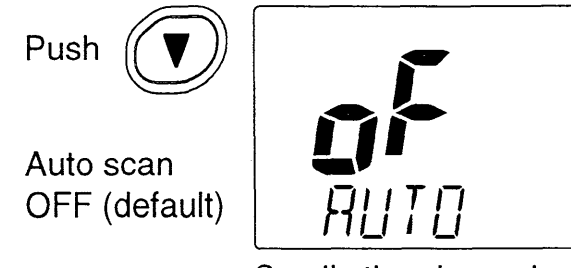
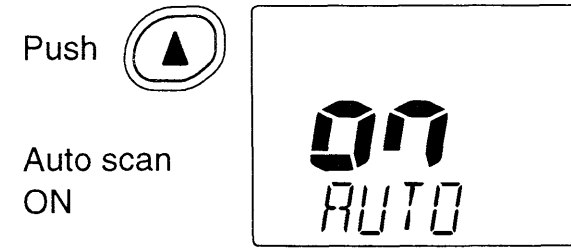

Scrolls the channel comment, “AUTO SCAN”.

8 SET MODE

◆ Automatic backlighting “BACKLIGHT”

This function is convenient for nighttime operation. The automatic backlighting turns the backlighting ON when pushing any key except for [PTT].

- The backlighting automatically turns OFF 5 sec. after operation.
- Push [MONI] to turn the backlighting ON without changing the operating condition.
- The backlight comes ON when entering SET mode, regardless of this setting.

Push 

Automatic
backlighting
ON (default)



Push 

Automatic
backlighting
OFF



Scrolls the channel
comment, “BACKLIGHT”.

◆ Power save function “POWER SAVE”

The power save function reduces current drain by deactivating the receiver circuit for fixed intervals.

 The power save function does not activate when the auto scan function is in use.

Push 

Power save
ON (default)

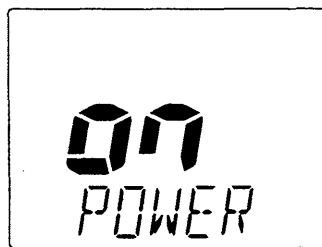

Push 

Power save
OFF

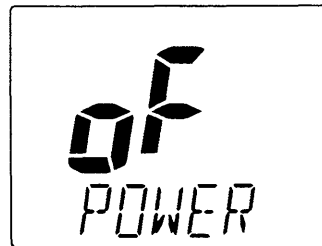

Scrolls the channel
comment, “POWER SAVE”.

◆ Self check function “SELF CHECK”

The self check function checks transceiver conditions by itself, and informs you in case a problem is found. The following items are checked after the power is turned ON, then, switches to operation mode.

- PLL lock (both transmit and receive)
- Temperature
- Connected battery voltage
- Water intrusion

Push 

Self check
function ON

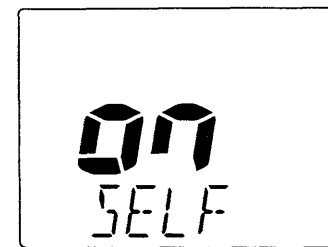

Push 

Self check
function OFF
(default)



Scrolls the channel
comment, “SELF CHECK”.

◆ **Scrambler unit selection**
 “SCRAM UNIT”

/// This item appears only when a voice scrambler unit is installed. This function may not be available in some countries due to local regulations.

Selects installed voice scrambler unit. Otherwise, the voice scrambler function cannot be operated.

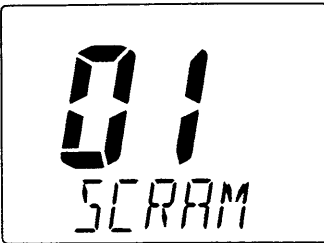
Push  

Selects UT-98 (default)

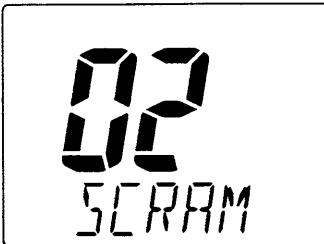
Push  

Selects UT-112

Scrolls the channel comment, “SCRAM UNIT”.

◆ **Scrambler code**
 “SCRAM CODE”

There are 128 codes (00 to 127) available with UT-98, or 32 codes (01 to 32) available with UT-112, for programming. In order to understand one another, all transceivers in your group must have the same unit* and scramble code.

*Different scrambling systems are used between UT-98 and UT-112, therefore the same scrambler unit must be used in your group.

Scrambling code 00* (default) 

*01 min. when UT-112 is installed.

Scrambling code 127* 

*32 max. when UT-112 is installed.

Scrolls the channel comment, “SCRAM CODE”.

■ Caution

NEVER incinerate used battery packs. Internal battery gas may cause an explosion.

NEVER immerse the battery pack in water. If the battery pack becomes wet, be sure to wipe it dry immediately (particularly the battery terminals) **BEFORE** attaching it to the transceiver. Otherwise, the terminals will become corroded, or cause connection failure, etc.

NEVER short the terminals of the battery pack. Also, current may flow into nearby metal objects, such as a necklace, etc. Therefore, be careful when carrying with, or placing near metal objects, carrying in handbags, etc.

AVOID leaving the battery pack in a fully charged, or completely discharged condition for long time. It causes shorter battery life. In case of leaving the battery pack unused for a long time, it must be kept safely after discharge, or use the battery until the battery indicator shows the middle level, then remove it from the transceiver.

If your battery pack seems to have no capacity even after being charged, completely discharge it by leaving the power ON overnight. Then, fully charge the battery pack again. If the battery pack still does not retain a charge (or very little), a new battery pack must be purchased.

■ Battery charging

Prior to using the transceiver for the first time, the battery pack must be fully charged for optimum life and operation.

CAUTION: To avoid damage to the transceiver, turn it OFF while charging.

- Recommended temperature range for charging:
+10°C to +40°C
- Use the supplied charger (AD-95) only. **NEVER** use another manufacturer's charger.
- An optional cable OPC-515L (for 13.8 V power source) or CP-17L (for 12 V cigarette lighter socket) can be used in-stead of the AC adapters of the supplied charger.

Recommendation:

Charge the supplied battery pack for a maximum of up to 8 hours. Li-Ion batteries are different from Ni-Cd batteries in that it is not necessary to completely charge and discharge them to prolong the battery life. Therefore, charge the battery in intervals, and not for extended periods is recommended.

◇ AD-95 installations

• To a desktop

Supplied screws

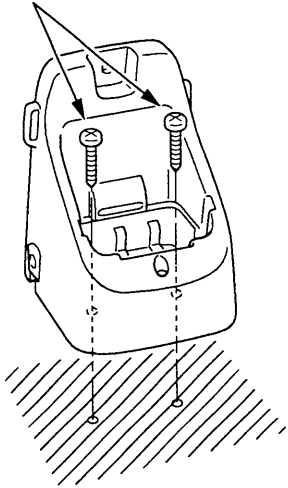

• To a wall

Supplied screws

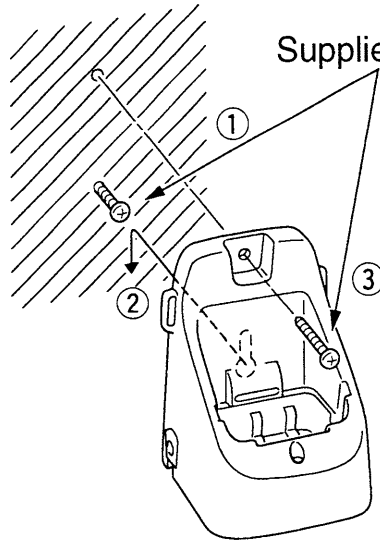

• For convenience:

Eyelet:
USE a rubber band to secure the transceiver, if desired.

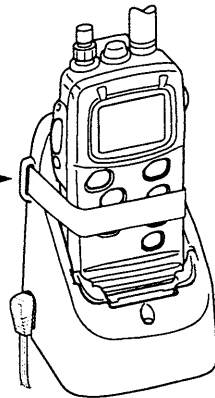

◇ Charging

- ① Connect the AC adapter (BC-122A/E/V) or optional cable (CP-17L or OPC-515L) as shown below.
- ② Insert the battery pack with/without the transceiver into the charger.
 - The charge indicator light shows green.
- ③ Charge the battery pack for approx. 8 hours, depending on the remaining power condition.

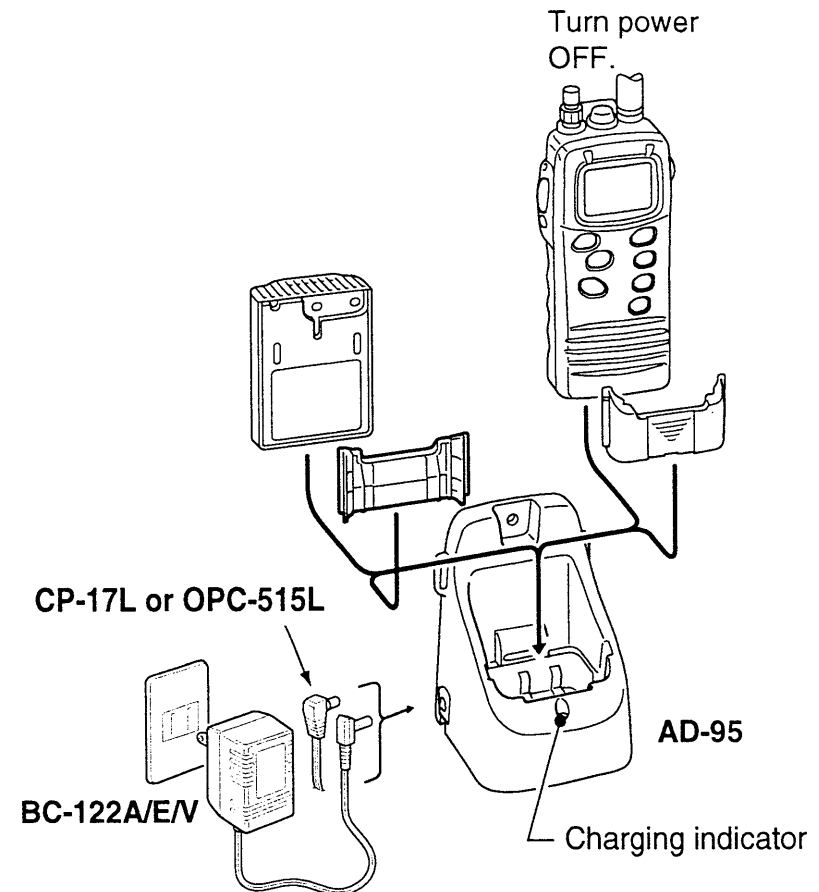

10 SPEAKER-MICROPHONE

■ Descriptions

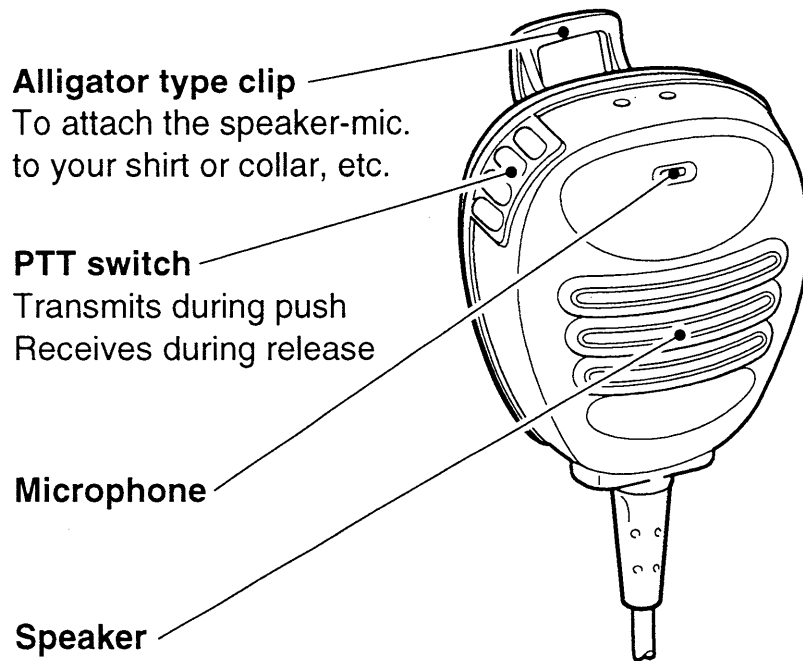

Alligator type clip
To attach the speaker-mic.
to your shirt or collar, etc.

PTT switch
Transmits during push
Receives during release

Microphone

Speaker

NEVER immerse the connector in water. If the connector becomes wet, be sure to dry **BEFORE** attaching it to the transceiver.

NOTE: The microphone is located at the top of the speaker-microphone, as shown in the diagram above. To maximize the readability of your transmitted signal (voice), hold the microphone approx. 2.5 cm from your mouth, and speak in a normal voice level.

■ Attachment

Insert the connector of the speaker-microphone into the [SP MIC] connector on the transceiver and rotate (screw) the connector cover as shown in the diagram below.

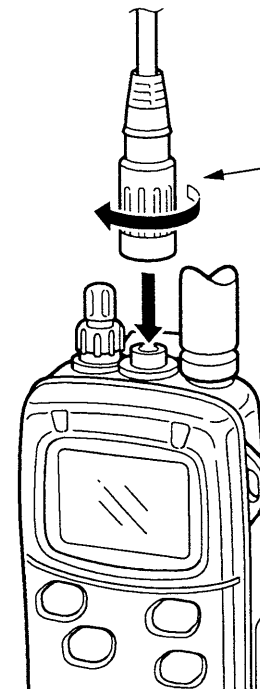

CAUTION: Attach the speaker-microphone's connector securely to prevent accidental dropping, or water intrusion in the connector.

IMPORTANT: KEEP the [SP MIC] jack cover attached (on the transceiver) when the speaker-microphone is not in use. Water will not get into the transceiver even if the cover is not attached, however, the terminals (pins) will become rusty, or the transceiver will function abnormally if the connector has become wet.

PROBLEM	POSSIBLE CAUSE	SOLUTION	REF.
No power comes ON.	<ul style="list-style-type: none"> •The battery is exhausted. •Bad connection of the battery pack. 	<ul style="list-style-type: none"> •Recharge the battery pack. •Check the connection to the transceiver. 	<p>p. 21</p> <p>p. 2</p>
No sound comes from the speaker	<ul style="list-style-type: none"> •Squelch level is too deep. •[VOL] level is too low. 	<ul style="list-style-type: none"> •Set squelch to the threshold point. •Set [VOL] to a suitable level. 	<p>p. 9</p> <p>p. 9</p>
Transmitting is impossible, or high power cannot be selected.	<ul style="list-style-type: none"> •Some channels are for low power or receive only. •The battery is exhausted. •The output power is set to low or extra low. 	<ul style="list-style-type: none"> •Change channels. •Recharge the battery pack. •Push [H/L] to select high power. 	<p>p. 7</p> <p>p. 21</p> <p>p. 9</p>
The displayed channel cannot be changed.	<ul style="list-style-type: none"> •Lock function is activated. 	<ul style="list-style-type: none"> •Push [H/L•LOCK] for 2 sec. to cancel the lock function. 	p. 8
Scan does not start.	<ul style="list-style-type: none"> •“TAG” channel is not programmed. 	<ul style="list-style-type: none"> •Set the desired channels as “TAG” channels. 	p. 13
Scan starts automatically.	<ul style="list-style-type: none"> •Auto scan function is activated. 	<ul style="list-style-type: none"> •Cancel the auto scan function in SET mode. 	p. 18
No beep sounds.	<ul style="list-style-type: none"> •Beep tone is turned OFF. 	<ul style="list-style-type: none"> •Turn the beep tone ON in SET mode. 	p. 16
Receive signal cannot be understood.	<ul style="list-style-type: none"> •Optional voice scrambler is turned OFF. •Scramble code is not set correctly. 	<ul style="list-style-type: none"> •Turn the optional voice scrambler ON. •Reset the scramble code. 	<p>p. 10</p> <p>p. 19</p>

12 CHANNEL LIST

Ch. No.		Frequency (MHz)	
INT	USA	Transmit	Receive
01		156.050	160.650
	01A	156.050	156.050
02		156.100	160.700
03		156.150	160.750
	03A	156.150	156.150
04		156.200	160.800
05		156.250	160.850
	05A	156.250	156.250
06	06	156.300	156.300
07		156.350	160.950
	07A	156.350	156.350
08	08	156.400	156.400
09	09	156.450	156.450
10	10	156.500	156.500
11	11	156.550	156.550
12	12	156.600	156.600
13 ^{*1}	13	156.650	156.650
14	14	156.700	156.700
15 ^{*1}	15 ^{*1}	156.750	156.750
16	16	156.800	156.800
17 ^{*1}	17	156.850	156.850
18		156.900	161.500
	18A	156.900	156.900
19		156.950	161.550
	19A	156.950	156.950
20	20	157.000	161.600

Ch. No.		Frequency (MHz)	
INT	USA	Transmit	Receive
	20A	157.000	157.000
21		157.050	161.650
	21A	157.050	157.050
22		157.100	161.700
	22A	157.100	157.100
23		157.150	161.750
	23A	157.150	157.150
24	24	157.200	161.800
25	25	157.250	161.850
26	26	157.300	161.900
27	27	157.350	161.950
28	28	157.400	162.000
30		157.500	162.100
31		157.550	162.150
37A	37A	157.850	157.850
60		156.025	160.625
61		156.075	160.675
	61A	156.075	156.075
62		156.125	160.725
		156.125	156.125
63		156.175	160.775
	63A	156.175	156.175
64		156.225	160.825
	64A	156.225	156.225
65		156.275	160.875
	65A	156.275	156.275

Ch. No.		Frequency (MHz)	
INT	USA	Transmit	Receive
66		156.325	160.925
	66A	156.325	156.325
67	67 ^{*1}	156.375	156.375
68	68	156.425	156.425
69	69	156.475	156.475
70 ^{*2}	70 ^{*2}	156.525	156.525
71	71	156.575	156.575
72	72	156.625	156.625
73	73	156.675	156.675
74	74	156.725	156.725
77	77 ^{*1}	156.875	156.875
78		156.925	161.525
	78A	156.925	156.925
79		156.975	161.575
	79A	156.975	156.975
80		157.025	161.625
	80A	157.025	157.025
81		157.075	161.675
	81A	157.075	157.075
82		157.125	161.725
	82A	157.125	157.125
83		157.175	161.775
	83A	157.175	157.175
84	84	157.225	161.825
	84A	157.225	157.225
85	85	157.275	161.875

Ch. No.		Frequency (MHz)	
INT	USA	Transmit	Receive
	85A	157.275	157.275
86	86	157.325	161.925
	86A	157.325	157.325
87	87	157.375	161.975
	87A	157.375	157.375
88	88	157.425	162.025
	88A	157.425	157.425

NOTE: Simplex channels, 3, 21, 23, 61, 64, 81, 82 and 83 **CAN-NOT** be lawfully used by the general public in USA waters.

*1Low power only.

*2Receive only.

QUICK REFERENCE 13

Important operating instructions are summed up in this and the following page for your simple reference.

By cutting along the line and folding on the dotted line, it will become a card sized operating guide which can easily be carried in a card case or wallet, etc.

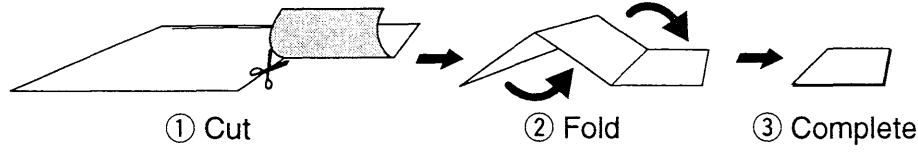

<CUT HERE>

COM OPERATION GUIDE C-M1EURO V

IN CASE OF EMERGENCY

- USING CHANNEL 16
- DISTRESS CALL PROCEDURE**
- 1. MAYDAY MAYDAY MAYDAY.
- 2. THIS IS (name of vessel)
- 3. Your call sign or other indication of the vessel.
- 4. LOCATED AT (your position)
- 5. The nature of the distress and assistance required.
- 6. Any other information which might facilitate the rescue.

CHANNEL SELECTION (pgs. 7, 8)

• Channel 16

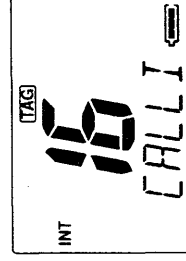

• Call channel

Push  for 1 sec.

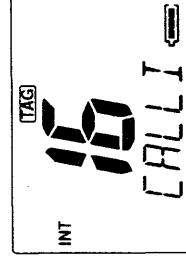

• Call channel programming (p. 11)

- ① Push [DIAL•I/U] for 1 sec. once or twice to select the desired channel group.
- ② Push [16•C] for 1 sec. to select the call channel.
- ③ Push [16•C] for 3 sec. (until long beep changes to 2 short beeps)
- ④ Push [▲/▼] to select the desired channel.
- ⑤ Push [16•C] to program the displayed channel as the call channel.

• International/USA channels (UK and Italian versions only)

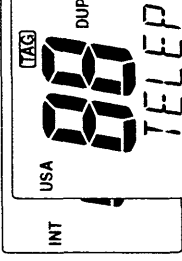

for 1 sec.

14 RECOMMENDATION

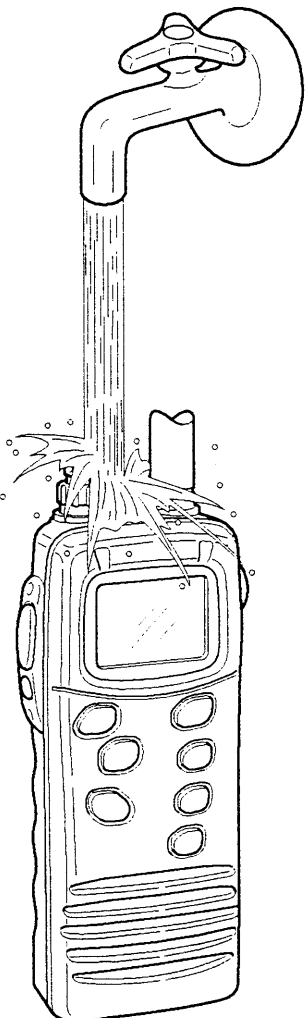

CLEAN THE TRANSCEIVER THOROUGHLY WITH FRESH WATER after exposure to salt water.

Otherwise, the transceiver's keys, switches and controllers may become inoperable due to salt crystallization.

SET MODE (pgs. 16—19)

① While pushing [MONI], turn power ON.



Refer to pgs. 16—19 for set mode item.

② Push [MONI] again to select an item.
 ③ Push [▲]/[▼] to select the desired condition.
 ④ Push [16•C] to return to regular operating mode.

VOICE SCRAMBLER (p. 10)

① Set a scrambler code in SET mode.

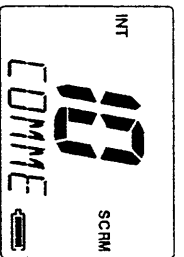

② While pushing [MONI], push [SCN•TAG] to turn the function ON and OFF.

Cannot be used on ch 16 or 70.

DUALWATCH/TRI-WATCH (p. 14)

- ① Push [▲]/[▼] to select the desired channel.
- ② For dual watch, push [DW•TRI].
For tri-watch, push [DW•TRI] for 1 sec.

SCAN (p. 13)

Push [SCN•TAG] to start/stop scanning.

TAG CHANNELS (p. 13)

- ① Push [▲]/[▼] to select the desired channel.
- ② Push [SCN•TAG] for 1 sec. to change the setting ON and OFF.

CHANNEL COMMENT (p. 15)

• Channel comment programming

- ① Push [▲]/[▼] to select the desired channel.
- ② Push [DW•TRI], while pushing [MONI].
- ③ Push [▲]/[▼] to select the desired characters.
- ④ Push [SCN•TAG] to move to right; [H/L•LOCK] to move to left.
- ⑤ Push [DW•TRI] to return to normal operating mode.

LOCK FUNCTION (p. 8)

Push  for 1 sec. to turn the lock function ON and OFF.

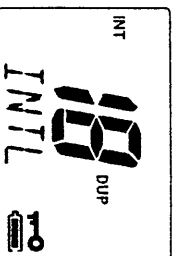

■ Specifications

• GENERAL

- Frequency coverage : Transmit 156–157.5 MHz
Receive 156–162 MHz
- Mode : FM (16K0G3E)
- Channel spacing : 25 kHz
- Current drain (at 7.4 V) : TX at 5 W 1.5 A max.
Max.audio 200 mA max.
Power saved 20 mA typ.
- Power supply requirement : Icom battery pack; BP-215
- Frequency stability : ± 1.5 kHz (-15°C to $+55^{\circ}\text{C}$)
- Dimensions (with BP-215) : 52.5(W) \times 129(H) \times 30(D) mm
(Projections not included)
- Weight (with BP-215) : 280g

• TRANSMITTER

- Output power : 5, 1 and 0.5 W or 1 and 0.5 W
- Modulation system : Variable reactance frequency modulation
- Max. frequency deviation : ± 5.0 kHz
- Spurious emissions : Less than 0.25 μW

• RECEIVER

- Receive system : Double conversion superheterodyne
- Sensitivity (20 dB SINAD) : 1.0 μV typ. (emf)
- Squelch sensitivity : Less than 0.71 μV (at threshold)
- Intermodulation rejection ratio : More than 68 dB
- Spurious response rejection ratio: More than 70 dB
- Adjacent channel selectivity : More than 70 dB
- Audio output power : 200 mW at 10% distortion with an
8 Ω load

All stated specifications are subject to change without notice or obligations.

■ Options

• AD-95 BATTERY CHARGER + BC-122A/E AC ADAPTER

Used for regular charging of battery pack. The same as supplied with the transceiver. Charging time: approx. 8 hours

• BP-215 BATTERY PACK

Long life, Li-ion battery pack allowing 12–14 hrs.* operation. The same as supplied with the transceiver. 7.4 V/1600 mAh.

*Tx:Rx:Stand-by=5:5:90

• CP-17L CIGARETTE LIGHTER CABLE

Connects to a ship's or vehicle's cigarette lighter socket (12 V) for use with the AD-95.

• FA-S57V FLEXIBLE ANTENNA

Same as supplied with the transceiver.

• HM-125 SPEAKER-MICROPHONE

Full-sized waterproof (JIS grade 7; 1m/30 min.) speaker-microphone including alligator type clip to attach to your shirt or collar, etc.

• OPC-515L DC POWER CABLE

Used for charging a battery pack via an AD-95 with external power supply.

• UT-98 VOICE SCRAMBLER UNIT

Ensures private communication. 128 scrambling codes are available. The scrambling system is not compatible with UT-112. Available in some countries where licence conditions permit. Version 02 (#02) only can be used with the IC-M1V/M1EURO V (version 01 not compatible).

• UT-112 VOICE SCRAMBLER UNIT

Ensures private communication. 32 scrambling codes are available. The scrambling system is not compatible with UT-98. Available in some countries where licence conditions permit.

Count on us!

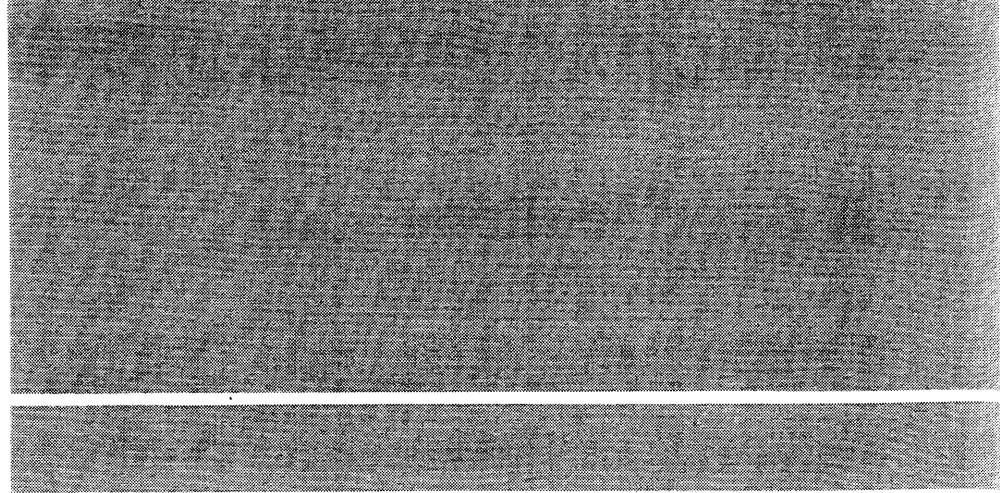

<Intended Country of Use>

- | | | |
|------------------------------|------------------------------|------------------------------|
| <input type="checkbox"/> GER | <input type="checkbox"/> NED | <input type="checkbox"/> ITA |
| <input type="checkbox"/> AUT | <input type="checkbox"/> BEL | <input type="checkbox"/> GRE |
| <input type="checkbox"/> GBR | <input type="checkbox"/> LUX | <input type="checkbox"/> SWE |
| <input type="checkbox"/> GER | <input type="checkbox"/> ESP | <input type="checkbox"/> DEN |
| <input type="checkbox"/> FRA | <input type="checkbox"/> POR | <input type="checkbox"/> FIN |